

REVISION HISTORY			
REV	DESCRIPTION	DATE	APPROVED

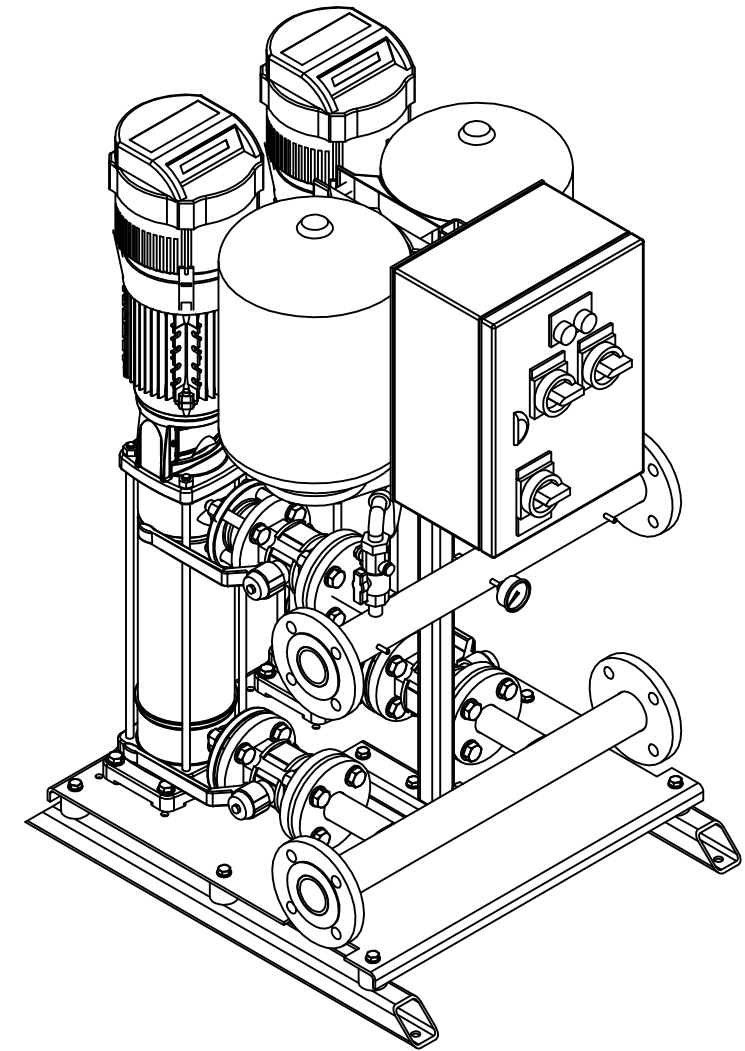

	NAME	DATE			
DRAWN	nigel	10/30/12			
CHECKED					
ENG APPR					
MGR APPR			TITLE		
UNLESS OTHERWISE SPECIFIED DIMENSIONS ARE IN MILLIMETERS ANGLES ±X.X° 2 PL ±X.XX 3 PL ±X.XXX			SIZE	DWG NO	REV
			A3	VR2-0516-LHT	
			FILE NAME: VR2-0516-LHT.dft		
SCALE:		WEIGHT:	SHEET 1 OF 1		