

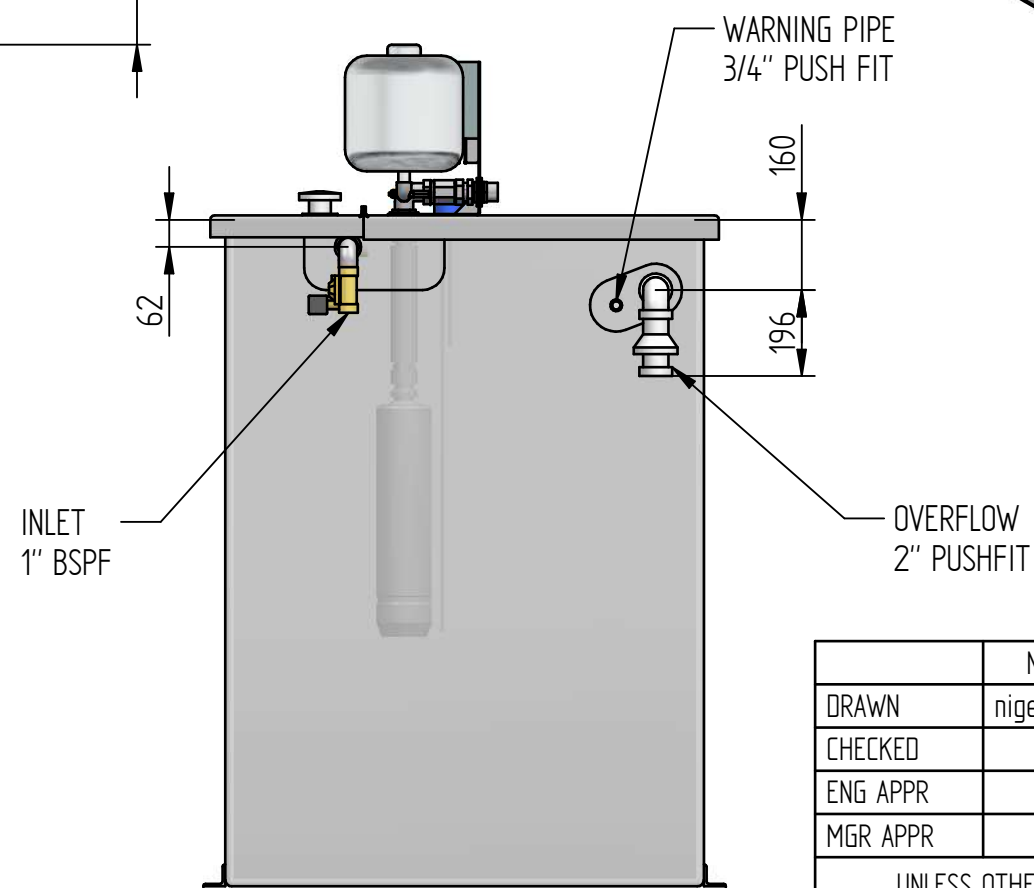

*
SIZES MAY INCREASE TO 2" FOR HIGH FLOW UNITS

REVISION HISTORY			
REV	DESCRIPTION	DATE	APPROVED

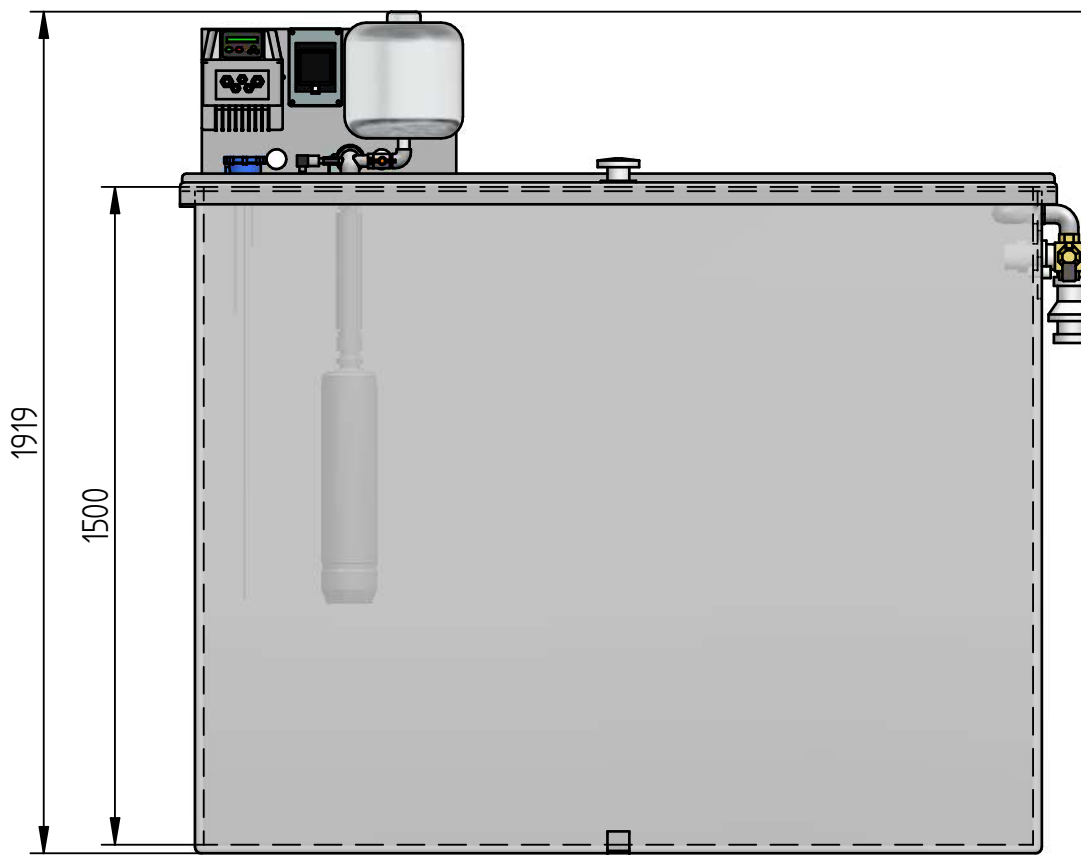
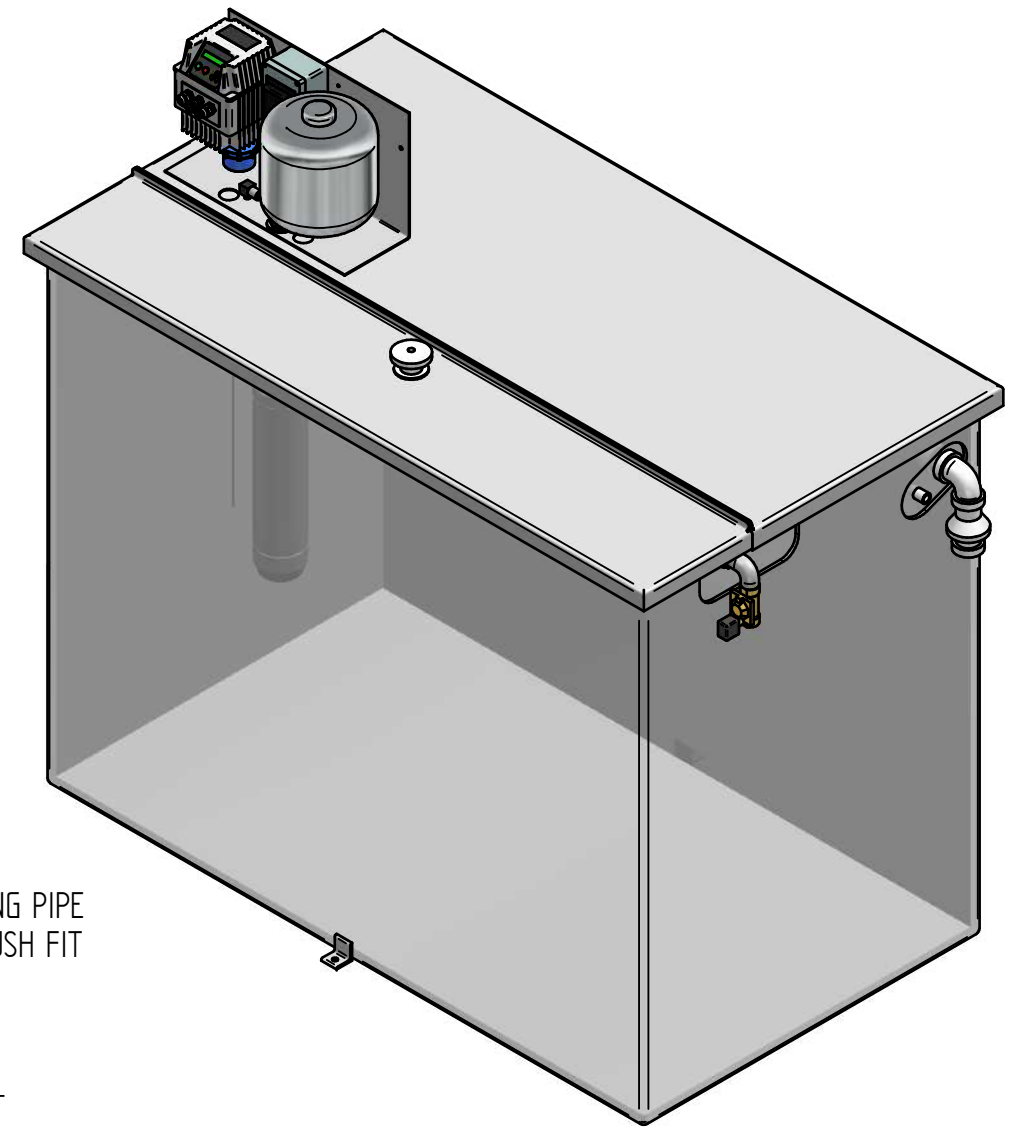
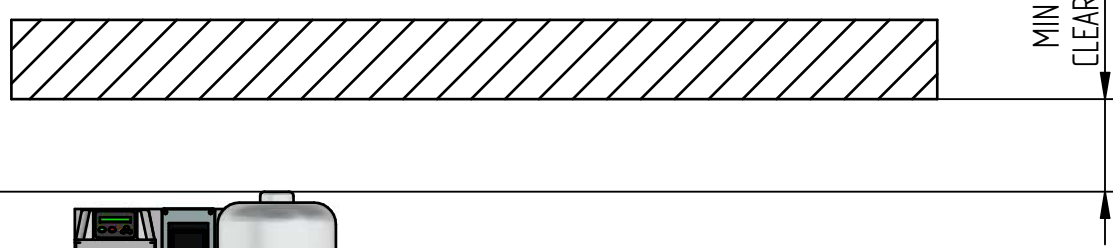

	NAME	DATE	 Dutypoint Systems		
DRAWN	nigel	05/03/13			
CHECKED					
ENG APPR					
MGR APPR			TITLE SCUBATANK 2250 SINGLE		
UNLESS OTHERWISE SPECIFIED DIMENSIONS ARE IN MILLIMETERS ANGLES ±X.X° 2 PL ±X.XX 3 PL ±X.XXX			SIZE A3	DWG NO SCUBATANK 2250 SINGLE	REV
			FILE NAME: SCUBATANK 2250.dft		
SCALE:		WEIGHT:	SHEET 1 OF 1		